

JUST BLACK TRIMLESS SYSTEM SPECIFICATION SHEET

PROJECT	_____
TYPE	_____
NOTES	_____
QUANTITY	_____
DATE	_____

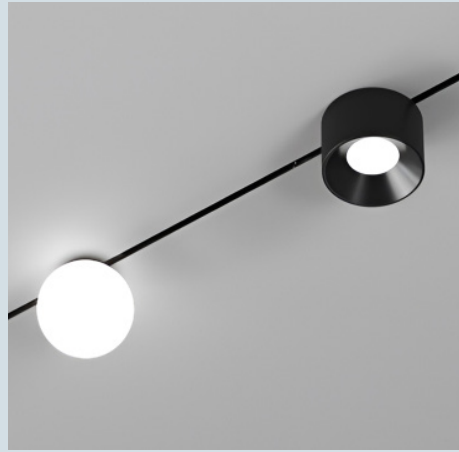

ARCHITECTURAL | JUST BLACK

The JUST BLACK product family is a comprehensive and versatile lighting solution in which a 5 millimeter-thin black line defines the path of the light. The trimless track blends almost seamlessly into the wall and ensures a visually flawless and maximally concealed appearance. With 90° connectors, the system can change directions, whether on the same level or at the transition between wall and ceiling.



Just Black 24V inserts are magnetically attached for easy installation, replacement and combination. They offer unrivaled flexibility to meet any requirement. Whether you prefer spotlights for focused lighting or a continuous LED line for homogeneous illumination, these inserts give you the freedom to create your lighting design as you wish.

SYSTEM PROFILE

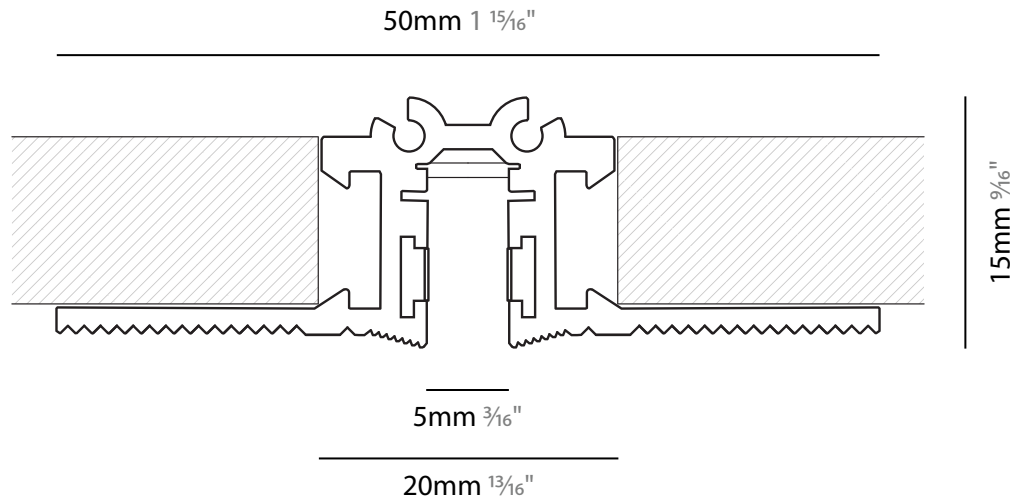

JUST BLACK TRIMLESS SYSTEM SPECIFICATION SHEET

PROJECT _____
 TYPE _____
 NOTES _____
 QUANTITY _____
 DATE _____

SYSTEM GUIDE

To make your product selection and complete system specification, proceed with the following:
 review system options, create your system code in the field below and include your quantity.
 For the inserts and components, use the field beside each product name.
 Submit to quotes@zaneen.com to receive a formal BOM and finalized model numbers.



UPON REQUEST
 Additional Options _____
 Color Temperature _____
 Lumen Outputs _____
 CRI _____

EXAMPLE A3JB-TRM-SYS-UNV-DN-1'-S

SYSTEM BUILD CODE: A3JB-TRM-SYS- **qty**

ELECTRICAL	Voltage	Dimming	Circuit
	UNV - 120/277V	DN - Non Dimming	EMCIR - Emergency Circuit
	120 - 120V	DV - 0-10V (100-1%)	
	347 - 347V	DD - DALI (100-1%)	
	MT - Matter Dimming		

LAYOUT	Fixture Head Spacing	Run Shapes
	1' - on center	S _____' Straight
	2' - on center	L _____'x_____ ' Ceiling to Ceiling
	4' - on center	LV _____'x_____ ' Ceiling to Wall
	CUS (XX) - Custom Spotlights - Minimum distance of 2 1/2"	U _____'x_____ 'x_____ ' R _____'x_____ ' Rectangle

BILO

INSERT BUILD CODE EXAMPLE:
A3T376-DN

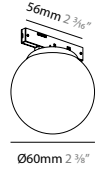
INSERTS	JUST BLACK BILO Ø60	A3T376-	qty	
	Wattage: 3.2W	Dimming	Delivered Lumen (lm)	
		DN - Non Dim	CCT - 90 CRI	
		DV - 0-10V	3000K	88
		DD - DALI		
	MT - Matter Dim			

FLEXLINE

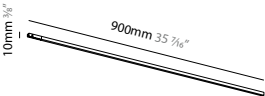
JUST BLACK FLEXLINE 900	A3T377-	qty	
Wattage: 6.8W	Dimming	Delivered Lumen (lm)	
	DN - Non Dim	CCT - 90 CRI	
	DV - 0-10V	2700K	142
	DD - DALI		
	MT - Matter Dim		

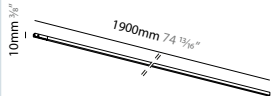
JUST BLACK FLEXLINE 1900	A3T378-	qty	
Wattage: 6.8W	Dimming	Delivered Lumen (lm)	
	DN - Non Dim	CCT - 90 CRI	
	DV - 0-10V	2700K	300
	DD - DALI		
	MT - Matter Dim		

JUST BLACK TRIMLESS SYSTEM SPECIFICATION SHEET

PROJECT	_____
TYPE	_____
NOTES	_____
QUANTITY	_____
DATE	_____

FLUTE

INSERTS

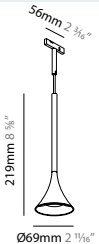
JUST BLACK FLUTE	A3T379 DN - Non Dim qty	
Wattage: 5.5W	Delivered Lumen (lm)	
	CCT - 90 CRI - Beam angle: 26°	
	3000K	407

HANGOVER

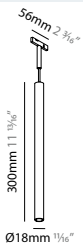
JUST BLACK HANGOVER	A3T380-	qty	
Wattage: 2.6W	Dimming	Delivered Lumen (lm)	
	DN - Non Dim	CCT - 90 CRI Beam angle: 22°	
	DV - 0-10V	3000K	144
	DD - DALI		
	MT - Matter Dim		

IMAGINE

JUST BLACK IMAGINE Ø25	A3T381- DN - Non Dim qty	
Wattage: 2.6W	Delivered Lumen (lm)	
	CCT - 90 CRI - Beam angle: 18°	
	3000K	138

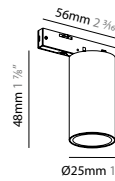
JUST BLACK IMAGINE Ø25	A3T382- DN - Non Dim qty	
Wattage: 2.6W	Delivered Lumen (lm)	
	CCT - 90 CRI - Beam angle: 22°	
	3000K	136

JUST BLACK IMAGINE Ø25	A3T383- DN - Non Dim qty	
Wattage: 2.6W	Delivered Lumen (lm)	
	CCT - 90 CRI - Beam angle: 32°	
	3000K	124

JUST BLACK TRIMLESS SYSTEM SPECIFICATION SHEET

PROJECT	_____
TYPE	_____
NOTES	_____
QUANTITY	_____
DATE	_____

INSERTS

IMAGINE

JUST BLACK IMAGINE Ø35	A3T384-	qty	
Wattage: 5.5W	Dimming	Delivered Lumen (lm)	
	DN - Non Dim	CCT - 90 CRI Beam angle: 20°	
	DV - 0-10V	3000K	298
	DD - DALI		
	MT - Matter Dim		

JUST BLACK IMAGINE Ø35	A3T385-	qty	
Wattage: 5.5W	Dimming	Delivered Lumen (lm)	
	DN - Non Dim	CCT - 90 CRI Beam angle: 26°	
	DV - 0-10V	3000K	343
	DD - DALI		
	MT - Matter Dim		

JUST BLACK IMAGINE Ø35	A3T386-	qty	
Wattage: 5.5W	Dimming	Delivered Lumen (lm)	
	DN - Non Dim	CCT - 90 CRI Beam angle: 34°	
	DV - 0-10V	3000K	364
	DD - DALI		
	MT - Matter Dim		

JUST BLACK IMAGINE Ø35 H:83	A3xxxx-	qty	
Wattage: 5.5W	Dimming	Delivered Lumen (lm)	
	DN - Non Dim	CCT - 90 CRI Beam angle: 20°	
	DV - 0-10V	3000K	298
	DD - DALI		
	MT - Matter Dim		

JUST BLACK IMAGINE Ø35 H:83	A3xxxx-	qty	
Wattage: 5.5W	Dimming	Delivered Lumen (lm)	
	DN - Non Dim	CCT - 90 CRI Beam angle: 26°	
	DV - 0-10V	3000K	343
	DD - DALI		
	MT - Matter Dim		

JUST BLACK IMAGINE Ø45	A3T387-	qty	
Wattage: 8.7W	Dimming	Delivered Lumen (lm)	
	DN - Non Dim	CCT - 90 CRI Beam angle: 18°	
	DV - 0-10V	3000K	492
	DD - DALI		
	MT - Matter Dim		

JUST BLACK IMAGINE Ø45	A3T388-	qty	
Wattage: 8.7W	Dimming	Delivered Lumen (lm)	
	DN - Non Dim	CCT - 90 CRI Beam angle: 20°	
	DV - 0-10V	3000K	533
	DD - DALI		
	MT - Matter Dim		

JUST BLACK IMAGINE Ø45	A3T389-	qty	
Wattage: 8.7W	Dimming	Delivered Lumen (lm)	
	DN - Non Dim	CCT - 90 CRI Beam angle: 30°	
	DV - 0-10V	3000K	504
	DD - DALI		
	MT - Matter Dim		

A

JUST BLACK TRIMLESS SYSTEM SPECIFICATION SHEET

PROJECT	_____
TYPE	_____
NOTES	_____
QUANTITY	_____
DATE	_____

INSERTS

INVADER

JUST BLACK INVADER	A3T390-	qty	
Wattage: 5.3W	Dimming	Delivered Lumen (lm)	
	DN - Non Dim	CCT - 90 CRI Beam angle: 26°	
	DV - 0-10V	3000K	411
	DD - DALI		
	MT - Matter Dim		

LEDLINE

JUST BLACK LEDLINE 600	A3T391-	qty	
Wattage: 13.2W	Dimming	Delivered Lumen (lm)	
	DN - Non Dim	CCT - 90 CRI	
	DV - 0-10V	3000K	600
	DD - DALI		
	MT - Matter Dim		

JUST BLACK LEDLINE 900	A3T392-	qty	
Wattage: 19.8W	Dimming	Delivered Lumen (lm)	
	DN - Non Dim	CCT - 90 CRI	
	DV - 0-10V	3000K	900
	DD - DALI		
	MT - Matter Dim		

MAGIQ

JUST BLACK MAGIQ 200	A3T393-	qty	
Wattage: 9.2W	Dimming	Delivered Lumen (lm)	
	DN - Non Dim	CCT - 90 CRI Beam angle: 32°	
	DV - 0-10V	3000K	420
	DD - DALI		
	MT - Matter Dim		

JUST BLACK MAGIQ 300	A3T394-	qty	
Wattage: 13.8W	Dimming	Delivered Lumen (lm)	
	DN - Non Dim	CCT - 90 CRI Beam angle: 34°	
	DV - 0-10V	3000K	632
	DD - DALI		
	MT - Matter Dim		

SIGN

JUST BLACK INVADER	A3T395-	qty	
Wattage: 15.2W	Dimming	Delivered Lumen (lm)	
	DN - Non Dim	CCT - 90 CRI Beam angle: 96°	
	DV - 0-10V	3000K	1050
	DD - DALI		
	MT - Matter Dim		

PROJECT _____

TYPE _____

NOTES _____

QUANTITY _____

DATE _____

COMPONENTS

WALL/CEILING CABLE LOOP	A3T369	qty
<p>Ø17mm 5/8"</p> <p>30mm 1 1/8"</p>	<p>Mounting point for threading or suspension of the Plug-Cable from a ceiling or the wall.</p>	

WALL/CEILING CABLE ROLLER	A3T370	qty
<p>Ø17mm 5/8"</p> <p>75mm 2 7/8"</p>	<p>Mounting point for threading or suspension of the Plug-Cable from a ceiling or the wall. The roller allows storing of additional cable length.</p>	

SUSPENDED ROLLER	A3T371	qty
<p>Ø17mm 5/8"</p> <p>80mm 3 1/8"</p>	<p>The suspended roller allows storing of additional cable length.</p>	

PROJECT	_____
TYPE	_____
NOTES	_____
QUANTITY	_____
DATE	_____

SYSTEM SUMMARY

System

Type

Trimless (Non-IC type)
Rated for Dry Locations Ceiling and Wall Mounted

Approval Status

Certified to North American Standards

Emission

Refer to emission icon beside each light insert and symbol legend for descriptions

Profile

Measurement

w 50mm (1 15/16") x ht. 15mm (9/16")

Housing

Anodized extruded aluminum profile available per meter and field-cuttable
Profiles have a maximum length of 2000mm (6' 6 3/4") and joined together with couplers to ensure uniform appearance and easy installation

Cutout

w 20mm (13/16") x Profile Length + 2mm (1/16")

Drywall Ceiling Thickness

Any ceiling thickness can be possible

Recessed Depth

h 20mm (13/16")

Electrical

Connections

Luminaries are pre-wired by factory with track adapters

Power Feed

Located at the end of the rail next to the end cap.
If a different location is required, please specify
A connector is located on one end of the 24V profile channel to carry the electrical power from the supply unit - there is 50mm (1 15/16") of unusable space for inserts from the end cap.
Linear connector takes 70mm (2 3/4") of unusable space.
L connector takes 80mm x 80mm (3 1/8" x 3 1/8") of unusable space.
3 Wires - non-dimming
5 Wires - Dimming

LED Driver

Driver must be remote with supplied enclosure.
Maximum distance between the power supply and the last fixture on the circuit is 30' using a 18-gauge wire. The length of the fixture specified must be considered within the maximum distance of 3'. Provisions must be made on site for accessibility to the power supplies.
Electronic Class 2 driver, Universal 120V/277V
Non Dimming Driver and Dimming Driver.
Consult factory for driver cutsheet
If a different driver is required, please specify

Emergency Inverter Compatible

To be installed remotely, and provided by others
It can be located up to 250m away from the fixture

Emergency circuit wiring is available upon request (Isolated track with dedicated driver used for emergency circuit will connect to emergency battery pack - supplied by others)

General

Features

The Just Black product family is a comprehensive and versatile lighting solution in which a millimeter-thin black line defines the path of the light. The system has been specially developed to integrate different types of lighting into the most complex interior designs in a minimalist way.

The black color gives the track a purist and sleek look, which is particularly effective in hotels, restaurants and residential areas.

Custom Requests and Additional Options

Availability depends by insert, system, and configuration
Must consult factory and allow up to 5 business days for an answer

Color Temperature, CRI, and different outputs

Configuration

Consult factory for patterns or custom designs
Provide configuration drawings

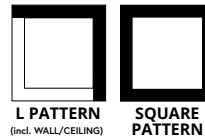

*Shop drawings provided upon receiving purchase order

Warranty

ZANEEN provides a limited warranty from date of purchase to original purchaser

LED Inserts: 5 year tested for 50,000 hours at 70% lumen output (L70)





































































LED Driver: 5 year

Non-Electrical Components: 1 year











*Check boxes to complete specification order and submit to quotes@zaneen.com to receive a formal BOM and a finalized model number

*In a constant effort to supply the best product, we reserve the right to change specifications or materials without notice. The most recent specification sheets are found at zaneen.com











LEGEND

	floor-mounted		pivotal		special LED (upon request) RGB, RGBW, tunable, gold+, meat+, art+, fashion+
	wall and ceiling: recessed and surface mounted		rotating		warm dim / natural dimming LED
	ceiling-mounted and wall-mounted		illuminate tilted		rechargeable battery powered
	wall-mounted		color of suspension cable		fixture with natural vivid LED (upon request)
	omni-directional light distribution		length of suspension cable		color rendering index
	direct light distribution		reflector degree selection		color temperature
	direct/indirect light distribution		super spot		lumen (luminous flux)
	indirect light distribution		lens		efficacy (lumens per watt)
	asymmetric light distribution		lens pack		Unified Glare Rating (UGR) range from 5-40
	aura light distribution		shine ring		marine grade (AISI 316 stainless steel)
	round wall or ceiling cut-out		integrated shine ring with diffuser		walk on
	square wall or ceiling cut-out		free individual colors 01-29		drive on
	the supplied jig specifies the cutout dimensions		individual colors: 00 (free of charge), 01-25 (extra charge)		Dark Sky Compliance
	minimum distance (meters) lamp - object		luminaire part to be colored (F1)		Americans with Disabilities Act (less than 4" off the wall located between 27"-84" from floor)
	recessed depth		luminaire part to be colored (F2)		lamp protected against explosion
	ceiling thickness in mm		luminaire part to be colored (F3)		blown glass using traditional methods by master glass blower
	ceiling thickness selection		luminaire part to be colored (F4)		acoustic material
	dimnable DP (phase), DV (0-10V), DD (dali), DS (step-dim)		luminaire part to be colored (F5)		protection class I, protection insulation
	included or excluded LED driver/transformer/control gear		color of 3-circuit adaptor		protection class II, protection insulation
	separately switchable		indirect diffuser		ETL Certified to UL and CSA Standards
	sensor		direct diffuser		UL Certified to UL and CSA Standards
	remote control		ball-proof (upon request)		CSA Certified to UL and CSA Standards
	available upon request		accessory		Certified for North American Standards

IP RATING

	protected against ingress of solid bodies greater than 12.5mm (finger)
	protected against ingress of solid bodies greater than 2.5mm protected against sprays of water up to 60 degrees from the vertical (rain)
	protected against ingress of solid bodies greater than 1mm (wire) no protection against the ingress of moisture
	protected against ingress of solid bodies greater than 1mm (wire) protected against sprays of water up to 60 degrees from the vertical (rain)
	protected against ingress of solid bodies greater than 1mm (wire) protected against water splashed from all directions
	protected against limited ingress of dust (wet rooms/covered outdoor areas) protected against water splashed from all directions
	protected against ingress of dust protected against jets of water
	protected against ingress of dust protected against powerful jets of water or heavy seas
	protected against ingress of dust protected against immersion of water between 15cm - 1m for 30 minutes
	protected against ingress of dust protected against immersion of water under pressure for long periods

IK RATING

	protected against 0.14 joules impact (equivalent to 0.25kg mass dropped from 56mm above the surface)
	protected against 0.2 joules impact (equivalent to 0.25kg mass dropped from 80mm above the surface)
	protected against 0.35 joules impact (equivalent to 0.25kg mass dropped from 140mm above the surface)
	protected against 0.5 joules impact (equivalent to 0.25kg mass dropped from 200mm above the surface)
	protected against 0.7 joules impact (equivalent to 0.25kg mass dropped from 280mm above the surface)
	protected against 1 joules impact (equivalent to 0.25kg mass dropped from 400mm above the surface)
	protected against 2 joules impact (equivalent to 0.5kg mass dropped from 400mm above the surface)
	protected against 5 joules impact (equivalent to 1.7kg mass dropped from 300mm above the surface)
	protected against 10 joules impact (equivalent to 5.0kg mass dropped from 200mm above the surface)
	protected against 20 joules impact (equivalent to 5.0kg mass dropped from 400mm above the surface)

WIRING DIAGRAMS

ALL ZANEEN FIXTURES ARE MANUFACTURED TO NORTH AMERICAN ELECTRICAL STANDARDS

Post Sales Support
HQ 1-800-388-3382 X 625 support@zaneen.com

IMPORTANT

- Do NOT connect directly to line voltage
- There is a minimum and maximum load per driver (See fixture and driver specifications).
- Fixture MUST be connected to LED driver, prior to turning power on

PHASE/NON-DIMMING WIRING DIAGRAM

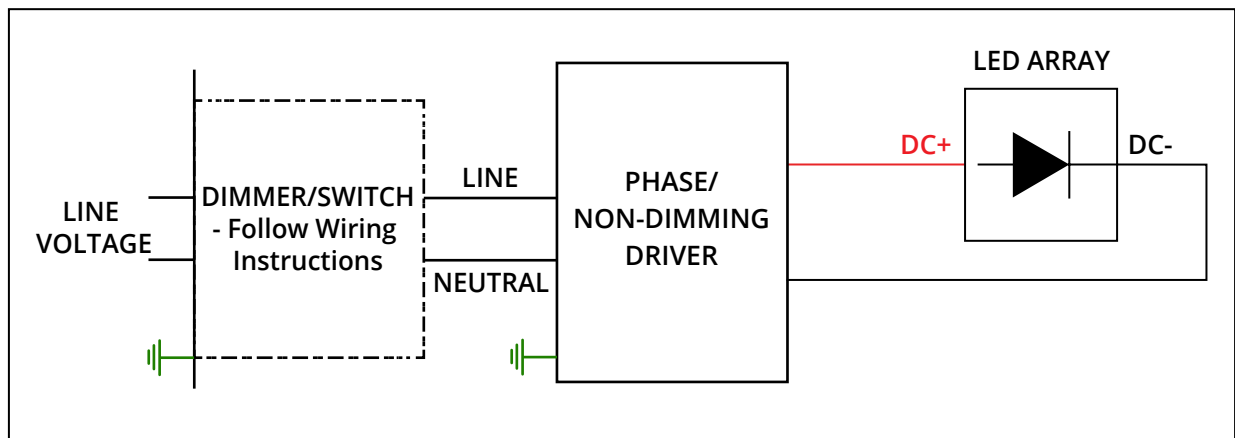

0-10V DIMMING WIRING DIAGRAM

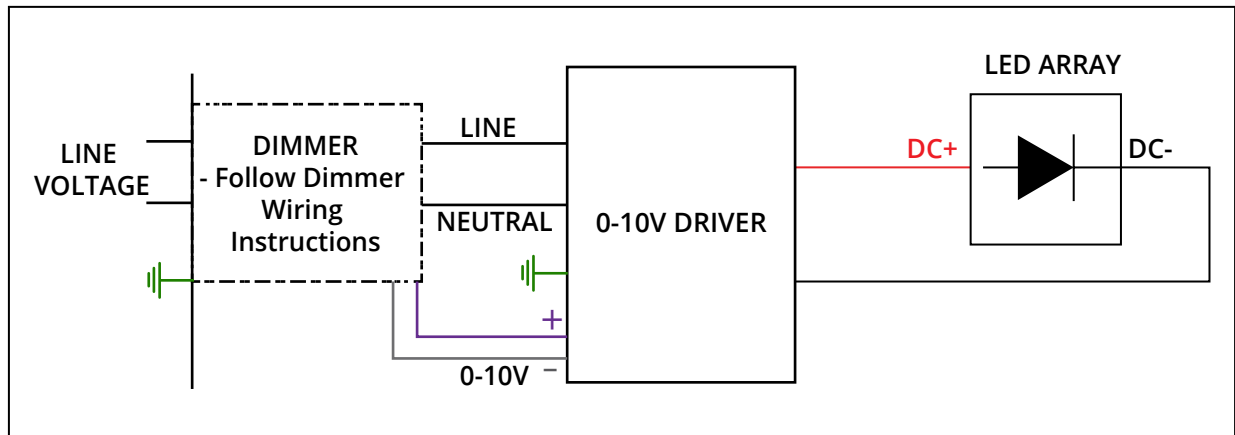

JUST BLACK TRIMLESS SYSTEM SPECIFICATION SHEET

PROJECT _____
TYPE _____
NOTES _____
QUANTITY _____
DATE _____

Insert custom drawing here or attach with additional pages

